



Push Rear Roller  
Cylinder Lawnmower

**WEH18**

193880002

## Operator's Manual

**Please read & understand this manual, paying particular attention to the safety instructions, before use.**

The manufacturer reserves the right to change the product specification and livery according to continues product improvements.





# **CONTENTS**

**SPECIFICATIONS**

**SAFETY INSTRUCTIONS**

**MAINTENANCE & STORAGE**

**COMPONENTS**

**ASSEMBLY**

**OPERATION**

**TROUBLE SHOOTING**

**PARTS DIAGRAM & LIST**

**WARRANTY**

**DECLARATION OF CONFORMITY**



## INSTRUCTION MANUAL





### SPECIFICATIONS

Model	WEH18
Product Number	193880002
Height of Cut	25mm-76mm
Collector	22 litre
Number of Blades	5
Blade Material	Hardened Steel

**The manufacturer reserves the right to change the product specification and livery according to continued product improvements.**

## SAFETY INSTRUCTIONS

Read and understand the owner's manual and labels affixed to the machine. Learn its application and limitations as well as the specific potential hazards. Retain these instructions for future reference. The operator is responsible for following the warnings & instructions in this manual and on the product.

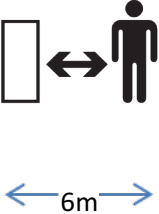
	<p>Read &amp; understand operator's manual before using the machine. Failure to follow instructions could result in death or serious injury.</p>		<p>DANGER</p>
	<p>Always wear thick gardening gloves to protect your hands when unpacking the machine or working with the cutting cylinder. SHARP ROTATING BLADES</p>		<p>Wear foot protection or sensible shoes when using the lawnmower</p>
	<p>Keep hands out of the way of all moving parts.</p>		<p>Keep all bystanders &amp; animals at least 6 metres away from the machine during operation. If approached, stop the machine immediately.</p>



Safety alert symbol. Used to alert you to potential personal injury hazards. Obey all safety messages that follow this symbol to avoid possible injury.



**DANGER**

Indicates an imminently hazardous situation which, if not avoided, will result in serious injury.



**WARNING**

Indicates a potentially hazardous situation which, if not avoided, could result in serious injury



**CAUTION**

Indicates a potentially hazardous situation which, if not avoided, may result in minor or moderate injury.

### CAUTION

Used without the safety alert symbol indicates a potentially hazardous situation which, if not avoided, may result in property damage.



## INSTRUCTION MANUAL

### **STAY ALERT**

Do not operate the lawnmower while under the influence of drugs, alcohol, or any medication that could affect your ability to use it properly. Do not use this lawnmower when you are tired or distracted from the job at hand. Be aware of what you are doing at all times. Use common sense.

### **AVOID DANGEROUS CONDITIONS**

Make sure there is adequate surrounding workspace. Cluttered areas invite injuries.

Keep your work area clean with sufficient light. Keep area around the lawnmower clear of obstructions, stones, sticks, wires and other debris or foreign bodies which could cause damage to the lawnmower.

### **INSPECT YOUR MACHINE**

Check all bolts, nuts, and screws for tightness before each use, especially those securing guards and drive mechanisms. Vibration during use may cause these to loosen.

Replace damaged, missing or failed parts before using.

Warning labels carry important information.

Replace any missing or damaged warning labels.

### **DRESS PROPERLY**

Do not wear loose clothing, gloves, scarfs, neckties or jewelry (rings, wrist watches), which can be caught in moving parts.

Wear protective hair covering to contain long hair, preventing it from getting caught in machinery.

DO NOT use whilst barefoot or wearing open toed footwear.

### **KEEP BYSTANDERS AND CHILDREN AWAY**

Keep unauthorised persons a minimum distance of 6 metres away from the machine. Do not allow children to handle, use, or climb on the lawnmower.

### **DO NOT OVERREACH**

Keep proper footing and balance at all times, particularly if using on slopes. The lawnmower should not be used on steep slopes and always be sure of footing.

### **AVOID INJURY FROM UNEXPECTED ACCIDENT**

Keep hands out of the way of moving parts, particularly the cutting cylinder. Do not place any part of your body or any tool e.g. Shovel in the drum during operation. When operating, do not pass hands through the clearance between frame, roller and cutting cylinder. The hardened steel blades are very sharp.

### **DO NOT FORCE TOOL**

Always work within the rated capacity. Do not use the machine for a purpose for which it was not intended.

### **MAINTAIN YOUR MACHINE WITH CARE**

Clean the lawnmower immediately after use. Keep the lawnmower clean to ensure it operates to its full and safest performance. When maintaining this lawnmower, only the manufacturer's original replacement parts should be used. The use of non-original manufacturer parts may invalidate your warranty.

### **STORE IDLE EQUIPMENT**

When not in use, the lawnmower should be stored in a dry location. Keep the lawnmower away from children and others not qualified to use it.

## MAINTENANCE & STORAGE



### WARNING

Improper maintenance & storage of the machine may void your warranty. Keep the machine clean for better and safer performance.

### MAINTENANCE

- Before each use, check all nuts & bolts to be sure they are sufficiently tightened.
- We recommend only manufacturer original parts are used when maintaining this machine. Failure to do so could invalidate your manufacturer's warranty.
- The cutting cylinder blades should be sharpened every two years, or sooner when damaged by foreign objects to maintain performance.

### CLEANING

- Keep your lawnmower clean.
- Thoroughly clean the lawnmower at the end of each use, paying attention to grass cuttings in and around the wheels, roller and blades.
- We suggest regular application of multi-purpose oil or lubricant (i.e WD-40). This should be applied to all cutting surfaces and cutting reel axle shaft.
- 



**Never put hands inside the cylinder when it is rotating.**

### STORAGE

- For years of trouble free service, make sure the lawnmower is clean and dry before storing.
- Before storing, clean the lawnmower thoroughly as indicated above.
- Store indoors or in a protected area during severe weather and winter months.



## INSTRUCTION MANUAL

### COMPONENTS

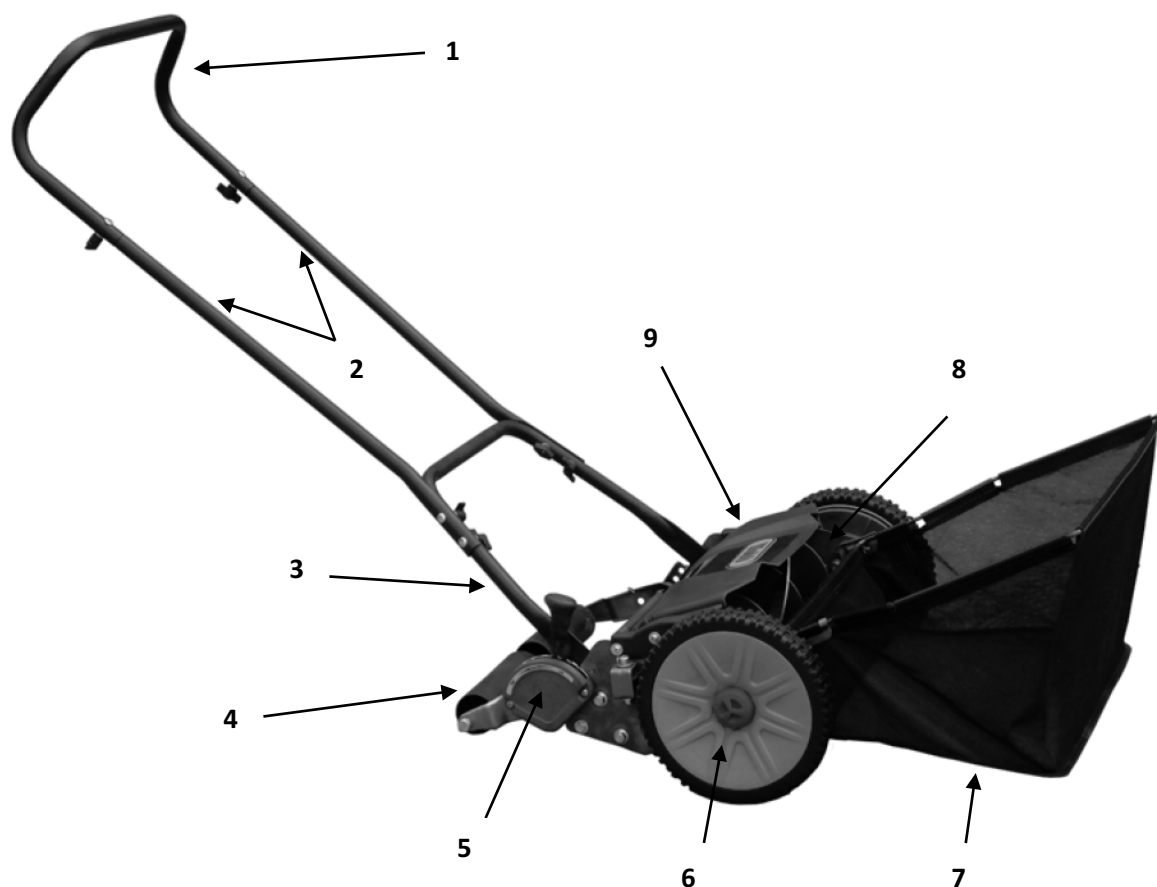

1. Top Handle
2. Mid Handles
3. Bottom Handle
4. Rear Roller
5. Height Adjustment Assembly
6. Wheel
7. Grass Collector
8. Cutting Cylinder
9. Grass Delivery Plate



## ASSEMBLY

It is recommended that you wear gardening gloves when unpacking, adjusting, assembling and maintaining the lawnmower.

Remove the machine and contents from the carton. Be sure the carton is empty before discarding.

If you require any assistance with regards to the contents of the lawnmower contact us:

Tel: 01793 333212 - Mon – Fri 8.00am – 5.30pm

Email: [customerservice@webblawnmowers.co.uk](mailto:customerservice@webblawnmowers.co.uk)

(excl. Bank Holidays)

### STEP 1 – HANDLE



#### CAUTION

This operation must be done close to the cutting cylinder blade. We strongly recommend the use of thick gardening gloves on both hands and the lawnmower body is secured to stop the cutting cylinder blade from rotating.

- Insert the middle handles into the top handle. Line up holes and insert bolt and tighten with wing nut. Ensure the concaved section of the middle handles are facing inwards.
- Slot the lower handle over the pins on the main body of the mower and secure with the supplied E-Clips.
- Align the middle handles to the lower handles, insert bolt and tighten with wing nuts x4.



Fig.2



Fig.3



Fig.4

### STEP 2 – GRASS COLLECTOR

- The grass collector has two positions, depending on the height of grass being cut.
- The upper torsion bar (Fig. 7 – a) is ideal for the upper cutting heights of the machine. If using the lower heights, position using lower torsion bar (Fig 7 – b).

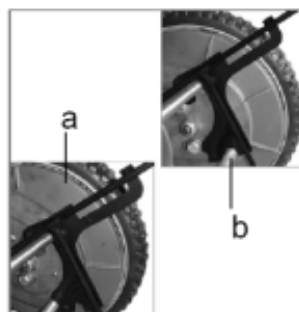

Fig.7



Fig.8



Fig.9



## INSTRUCTION MANUAL

### ADJUSTMENTS

#### CUTTING PERFORMANCE

**IMPORTANT:** The stay sharp system is engineered to cut grass without contact between the blades. This cutting system is precision set during the factory assembly process. However, since slippage may occur during shipping, handling or use, it is very important to check the cutting performance prior to first use and periodically thereafter. Slippage can occur in two directions, therefore the following two checks are recommended to evaluate cutting performance. Both checks should be performed on both the left and right sides of the mower. Checking the cutting performance and adjusting if needed, are the most important things you can do to ensure that your mower always performs to its optimum performance.

#### PREPARATION

You will need several 1" wide strips of standard printer paper, A4 size in length and a pair of sturdy gardening gloves.

#### CHECK 1: DO THE BLADES MAKE CONTACT?

To check if the blades make contact, face the front of the mower and slowly pull the cutting reel downwards, one blade at a time, through a full rotation. If you hear scrapping or feel resistance, skip to the Adjusting the Blade section of this manual.

NOTE: If the cutting reel and static bottom blade make contact, the mower will be difficult to push and will dull the blade.

#### CHECK 2: DO THE BLADES CUT CORRECTLY?

To check if the blades cut correctly, you will need to check the blades on both sides of the mower. To check the machine is cutting correctly, place a piece of good quality paper, along the whole length of the fixed bottom blade (from underneath the lawnmower), with each of the five cutting blades. This should provide evidence of a good even cut.

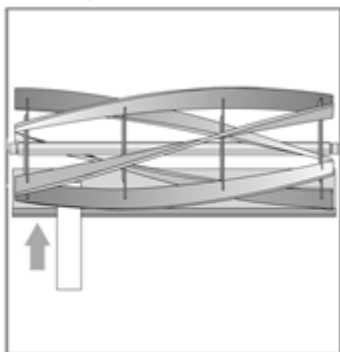

Fig.10



#### WARNING

**Keep your fingers away from the cutting area.**

If most of the blades cut on both sides, the cutting system is set correctly. If you experience any blades not cutting, go to Adjusting the Blade section of this manual.

### ADJUSTING THE BLADES

Before adjusting the blades, source a 13mm open end spanner(Not supplied).



**Fig.11**

Turn the two locking bolts (A & B) counter-clockwise on both side plates of your mower.

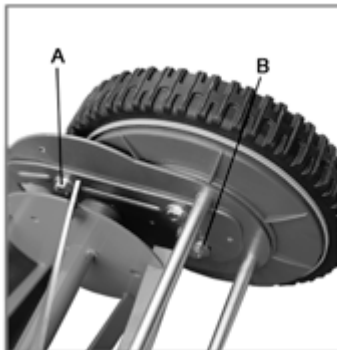

**Fig.12**

Adjust both top adjustment bolts positioned on both sides of your mower.

If the blades are making contact, turn the adjustment bolts clockwise, while rotating the cutting reel, stopping as soon as the blade lose contact.

If the blades did not cut the paper, turn the adjustment bolts counter clockwise, while rotating the cutting cylinder, until the blades make contact.

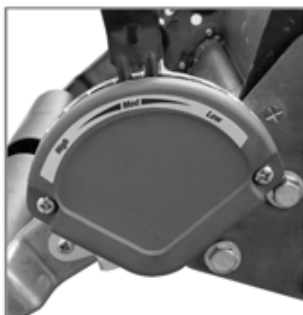

**Fig.13**

When properly adjusted, the cutting cylinder and bottom static blade should be just short of making contact. When the blades are correctly adjusted, firmly tighten the locking bolts on the side plates, you previously loosened. If issues still persist, repeat adjustment steps.

### ADJUSTING THE CUTTING HEIGHT

This mower has 9 cutting height settings, between 12-75mm. Move the height adjuster handle/arm up and down the guide for your chosen height of cut.



**Fig.14**



## INSTRUCTION MANUAL

### OPERATION

Before operating the machine, please ensure you are fully aware of the instructions, failure to do so, could invalidate your manufacturer's warranty.

1. Walk briskly for maximum cutting power. The faster you walk, the better the mower will cut. Never run!
2. For best results, place the lawnmower on the edge of the lawn, mow around the edge of the lawn area, pushing the mower in front of you.
3. Then mow at right angles and at the end of each turn, slightly overlapping the previously cut strip.

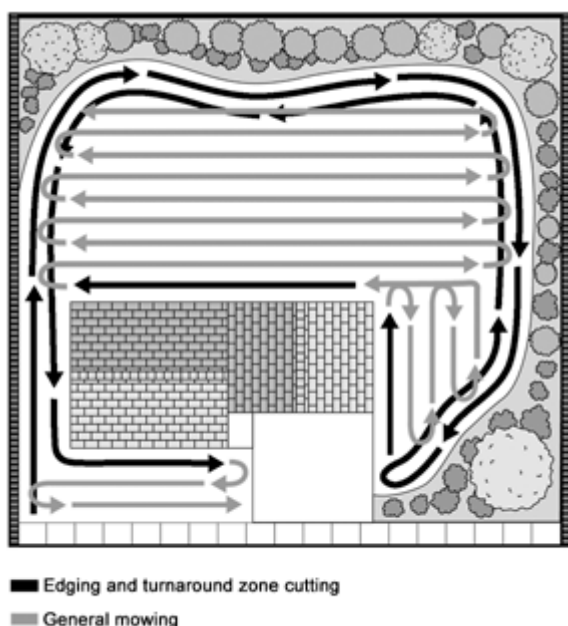
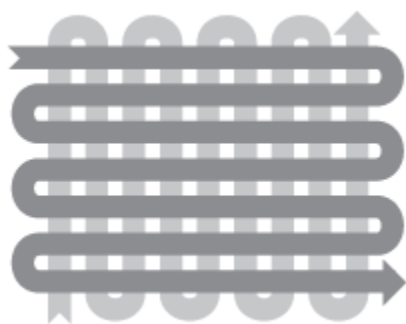

Fig.15

4. The next time you mow the lawn, try to work at right angles to the previous cut. This will help prevent unevenness in the soil surface, which can build up if you always mow in the same direction.



### MOWING TIPS

Prior to any cutting, check the cutting area for any debris in advance. Remove stones, bricks, trash and other debris which could cause damage to the cutting blade. If you hit debris, check the blades. If damaged, refer to your nearest approved service dealer for assistance.

To maintain a healthy lawn and eliminate the mess created by very long grass, cut off no more than one-third of the grass length as a time. If more than 1/3 of the length is removed, root growth will be impaired and grass will be stressed, making your lawn susceptible to weed invasion, disease and poor appearance. If your lawn gets too high, cut off 1/3 of the length, wait a couple of days and then cut off another third.

## MAINTENANCE & STORAGE



### WARNING

Improper maintenance & storage of the machine may void your warranty. Keep the machine clean for better and safer performance.

### MAINTENANCE

- Before each use, check all nuts & bolts to be sure they are sufficiently tightened.
- We recommend only manufacturer original parts are used when maintaining this machine. Failure to do so could invalidate your manufacturer's warranty.
- The cutting cylinder blades should be sharpened every two years, or sooner when damaged by foreign objects to maintain performance.

### CLEANING

- Keep your lawnmower clean.
- Thoroughly clean the lawnmower at the end of each use, paying particular attention to grass cuttings in and around the wheels, roller and blades.
- We suggest regular application of multi-purpose oil or lubricant (i.e WD-40). This should be applied to all cutting surfaces and cutting reel axle shaft.



**Never put hands inside the cylinder when it is rotating.**

### STORAGE

- For years of trouble free service, make sure the lawnmower is clean and dry before storing.
- Before storing, clean the lawnmower thoroughly as indicated above.
- Store indoors or in a protected area during severe weather and winter months.

## TROUBLE SHOOTING

Problem	Answer	Fix
The lawnmower is not cutting?	Blade adjustment required Height adjustment required	<b>See Blade Adjustment Instructions</b> <b>Adjust cutting height</b>
I'm not collecting much grass?	Grass is too long	<b>Adjust cutting height</b>
My mower is not moving freely?	Blades are contacting	<b>See Blade Adjustment Instructions</b>
The cut is uneven?	The blade may be damaged  Blade adjustment required Height adjustment required	<b>Visit your local Webb dealer to have the blade inspected.</b> <b>See Blade Adjustment Instructions</b> <b>Adjust cutting height</b>

# PARTS DIAGRAM

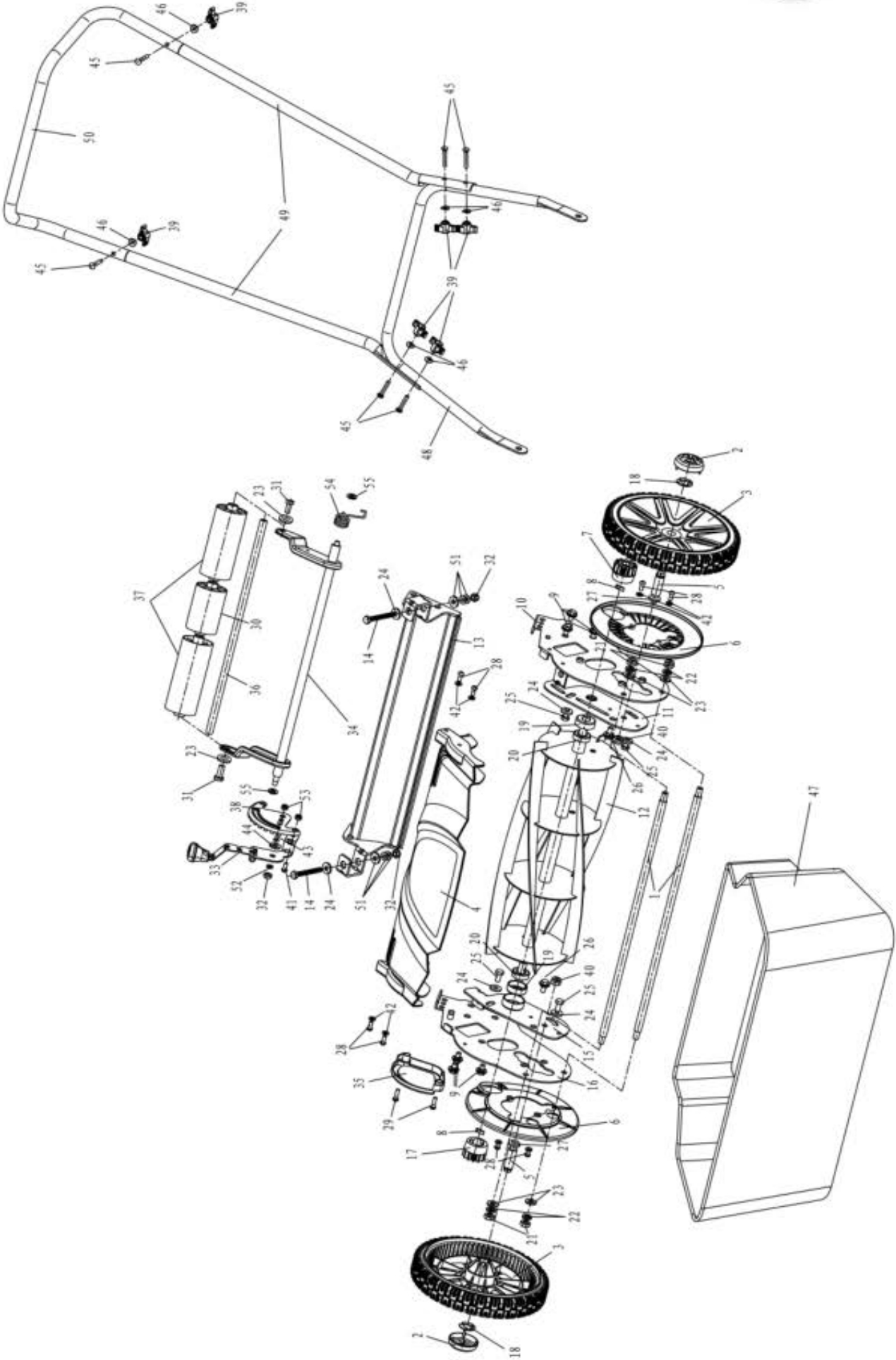

# PARTS LIST

Item No.	Part. No.	Description	Qty
1	WE105-01	Side Plate Torsion bar	2
2	WE105-02	Hub Cap	2
3	WE105-03	Wheel Assembly	2
4	WE105-04	Grass Delivery Plate	1
5	WE105-05	Axle	2
6	WE105-06	Side cover	2
7	WE105-07	Left Gear	1
8	WE105-08	Pawl	2
9	WE105-09	Cutter Bar Lock Nut	6
10	WE105-10	Left Side Plate Assembly	1
11	WE105-11	Left adjuster plate	1
12	WE105-12	Reel Assembly	1
13	WE105-13	Cutter Bar Assembly	1
14	WE105-14	Hex Bolt M8X55	2
15	WE105-15	Right adjuster plate	1
16	WE105-16	Right Side Plate Assembly	1
17	WE105-17	Right Gear	1
18	WE105-18	E Ring 12	2
19	WE105-19	Bearing Cap	2
20	WE105-20	Bearing 6002-2Z	2
21	WE105-21	Hex Head Nut M10	4
22	WE105-22	Spring washer 10	4
23	WE105-23	Washer 10	6
24	WE105-24	Washer 8	8
25	WE105-25	Hex Head Bolt M8X16	4
26	WE105-26	Bolt	2
27	WE105-27	Washer 10	2

Item No.	Part. No.	Description	Qty
28	WE105-28	Head Bolt M6X10	8
29	WE105-29	Head Bolt M6X20	2
30	WE105-56	Roller Small	1
31	WE105-31	Bolt	2
32	WE105-32	Spring Washer 10	5
33	WE105-33	Height Adjuster Handle	1
34	WE105-34	Height Adjuster Assembly	1
35	WE105-35	Adjuster Cap	1
36	WE105-36	Roller Tube	2
37	WE105-57	Roller Large	2
38	WE105-38	Roller Adjuster	1
39	WE105-39	Knob	6
40	WE105-40	Lock Nut M10	2
41	WE105-41	Head Bolt M6X12	1
42	WE105-42	Washer 6	9
43	WE105-43	Screw M6X14	1
44	WE105-44	Washer 10	1
45	WE105-45	Carriage Bolt M8X50	6
46	WE105-46	U Washer	6
47	WE105-47	Grass Catcher	1
48	WE105-48	Lower Handle	1
49	WE105-49	Middle Handle	2
50	WE105-50	Upper Handle	1
51	WE105-51	Push Bearing	2
52	WE105-52	Washer 8	1
53	WE105-53	Lock Nut M6	2
54	WE105-54	Spring	1
55	WE105-55	Plastic Washer	2



## EC DECLARATION OF CONFORMITY

**We Handy Distribution Ltd - SN3 5HY (Importer) declare that the product:**

**Designation:** Hand Push 18" Cylinder Rear Roller Lawnmower

**Model(s):** WEH18

**Product No.:** 193880002

**Type/Serial No.** As per rating label on machine

**Complies with the following directives:**

2006/42/EC - Machinery Directive

**The conformity assessment procedure followed was in accordance with**

EN ISO 12100:2010,

**Notified Bodies:**

*Global Testing Services Ltd, No 968 Meilong West Road, Minhang District, Shanghai, 201104  
Shanghai BVCE Certification Testing Technologies Co. Ltd, 4D1th Building, Dongming Square,  
Lujiazui, Pudong New Area, Shanghai City, China.*

**Authorised signatory and technical file holder**

**Date:** 27/09/2017

**Signature:** 

**Name:** Mr Simon Belcher

**Position:** Managing Director

**Company:** Handy Distribution Ltd

**Address:** Murdock Rd, Swindon, Wiltshire, SN3 5HY.









## INSTRUCTION MANUAL

This Service Book is provided with your Webb, to help you look after your purchase to our recommendations and enable you to take advantage of the 2 year conditional manufacturer domestic warranty\*.

\* Commercial/Professional & Hire users receive a 90 day warranty

Present this service book to your authorised Webb repair dealer, whenever a service or a warranty appraisal is required.

The booklet is applicable to the following products, in the UK only:

- Ride On Lawn Tractors
- Cylinder Lawnmowers
- Petrol Rotary Lawnmowers
- Petrol Hand Held Range

Please register your machine using the following pages or at [www.webbgardenpower.co.uk](http://www.webbgardenpower.co.uk). By registering your machine, you agree to maintain the machine in accordance with the service schedules specified in this manual and services duly recorded. You may be asked to produce this booklet as proof of servicing in the event of a claim. Proof of purchase should also be kept as a reference.

Ensure you have the following information available from your machine product label. The two examples below can be found on your machine:



1. Model Number

---

2. Serial & Product Number

---

Please complete using BLOCK CAPITALS.  
Sections marked\* must be completed to validate Warranty.

# SERVICE BOOK

## 1. Users Statement of Warranty

Each new machine is warranted against defective material or assembly of material under normal usage. The warranty applies to the original purchaser, is not transferable and covers faulty parts and the labour involved in replacing and repairing those parts, which are of original manufacture.

## 2. Period of Warranty

2 year conditional warranty from the original date of sale to the first domestic user.

90 days from the original date of sale to the professional/commercial or for hire user.

Engine warranty as per the engine manufacturer's warranty, which will be supplied with the machine.

90 days from the original date of sale for Replacement Spare Parts

All machines' must be serviced within the first 14 months from the original date of purchase, to qualify for a second year parts & labour warranty, details of the service must be recorded in the service record within this manual.

A reduced warranty period of 90 days applies to those items which are subject to normal wear and tear and in normal use, will need replacement or adjustment.

These items are chargeable after 90 days of ownership.

Filters  
Tyres / Wheels  
Drive chains and belts  
Brake & clutch friction components  
Control cable & starter cords  
Fluids & lubricants  
Spark plugs  
Blades (Lawnmowers & Brushcutters)  
Cutter bars (Hedgecutters)  
Drive & clutch cable surfaces  
Nylon Lines (Line Trimmers)  
Carburettor cleaning  
Bearings  
Bushes  
Electric cable  
Grass collectors

## 3. Not covered by this warranty

(a) The warranty policy does not cover any depreciation or damages caused by ordinary wear, rusting or corrosion, lack of correct maintenance or operation, misuse, abuse, lack of transportation or accident.

(b) The warranty policy does not cover any costs necessary for the standard periodic maintenance services instructed by the operators manual, or service parts replacement which would include oil, filters, tyres, belts, brake linings, fuses, blades, seals and other service parts unless it can be proven that the item has evidence of faulty manufacture.

(c) The warranty policy will not cover failure or damage caused as a result of parts or accessories being modified without the written approval of GJ Handy & Co Ltd.

(d) The warranty policy will not cover the unit if non-genuine parts have been fitted and as a result damage has occurred to the unit.

(e) The warranty policy is non-transferable and is only applicable to the original purchaser.

## 4. Disclaimer

(a) This warranty is only a remedy for defect of products. GJ Handy & Co Ltd will never warranty in terms of the merchantability or the fitness for a particular purpose.

(b) No person is authorised to make any warranties, representations or promises, expressed or implied, on behalf of GJ Handy & Co Ltd, or to modify the terms conditions or limitation of this warranty policy in any way.

(c) Neither GJ Handy & Co Ltd nor any company affiliated with GJ Handy & Co Ltd shall be liable in any event or manner whatsoever for incidental or consequential damages or injuries, including, but not limited to, loss of crops, loss of profit, out of pocket expenses or profits, rental of substitute equipment or other commercial losses.



## INSTRUCTION MANUAL

### **5. General**

- (a) Most warrantable failures show up within the first few weeks of use. These failures are usually straightforward and warranty assessment is relatively easy.
- (b) Failures relating to cutter decks and belts need careful investigation, as the cause may not always be straightforward. Look for damage to blades and pulleys especially when the cutter belt or blade boss have snapped or cracked as this could be due to impact damage.
- (c) Customers should always refer to the operator/instruction manual when any disputed problem arises, you will find most areas covered within the manual.

## Protecting your machine

### **Maintenance**

Regular maintenance of your Webb machine is essential to ensure it operates, safely, efficiently and therefore reducing the environmental impact.

It is the owner's responsibility to ensure that their Webb machine is maintained at specific intervals. Any approved Webb service dealer can undertake a service, which are specialised in our products and will be aware of your particular machine and any technical updates which will save valuable time & money.

If you are using your machine in dry, dusty or high temperatures, you will need to service the machine more regularly.

### **Fuel**

Due to ongoing efforts by fuel companies to reduce emissions, unleaded petrol will oxidize & deteriorate in storage overtime, leaving residue from detergent components.

Fuel deterioration problems may occur when petrol is stored for over 30 days. If you are planning to store fuel for over 30 days, we recommend you add Handy Parts Sure-Start fuel stabilizer to fresh fuel after purchasing. Sure-Start cannot reconstitute stale fuel.

### **Storage**

When storing your machine for an extended period, we do recommend that you follow the instructions of engine instruction manual.

Always store the fuel in a clean, approved and sealed container. If the container is steel, ensure it is not corroded.

If the container is not filled to its recommended capacity, air can accelerate fuel deterioration.

Always store fuel away from direct sunlight, in a dark, cool environment.

# SERVICE BOOK

Your servicing Webb approved dealer will stamp & date the below relevant sections, when the correct service actions have been completed.  
PLEASE ENSURE THE SERVICE BOOK IS AVAILABLE FOR THE DEALER, DURING SERVICE WORK.

## 1st Service

This must be stamped by an approved service dealer to qualify for a free second year warranty.

12 Months

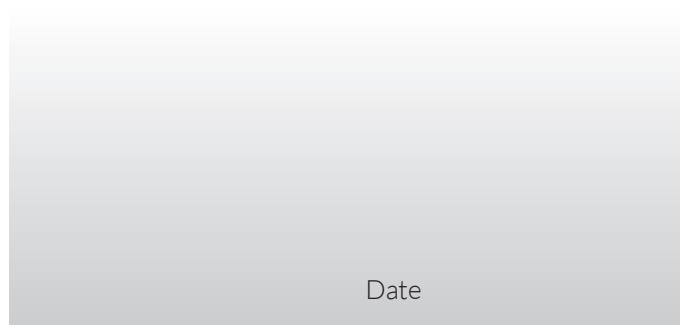

Date

24 Months

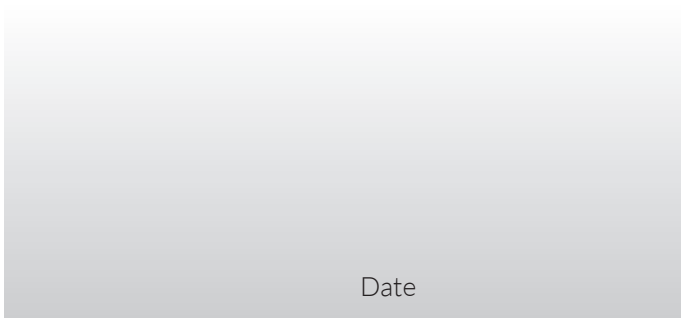

Date

36 Months

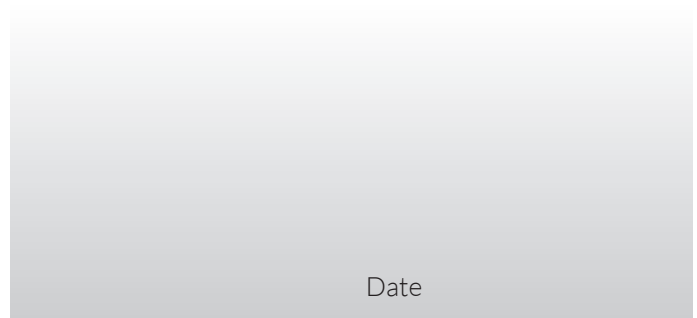

Date



# INSTRUCTION MANUAL

48 Months

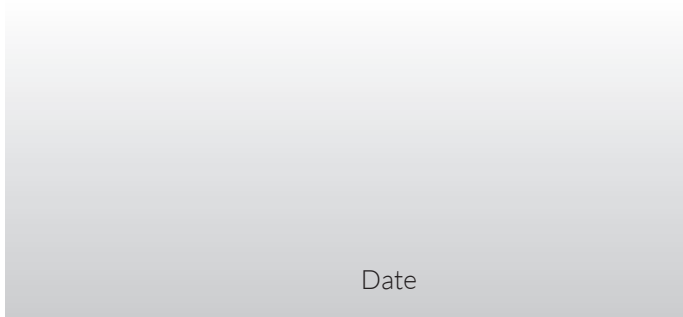

Date

60 Months

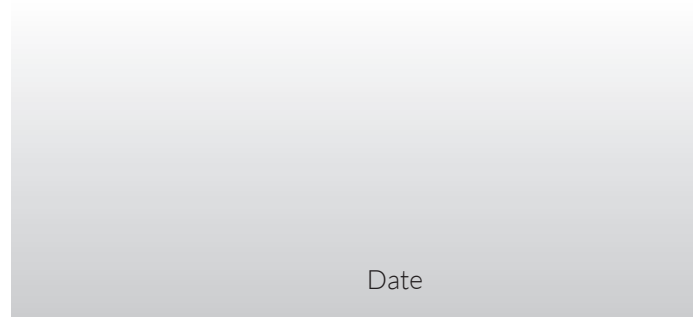

Date

72 Months

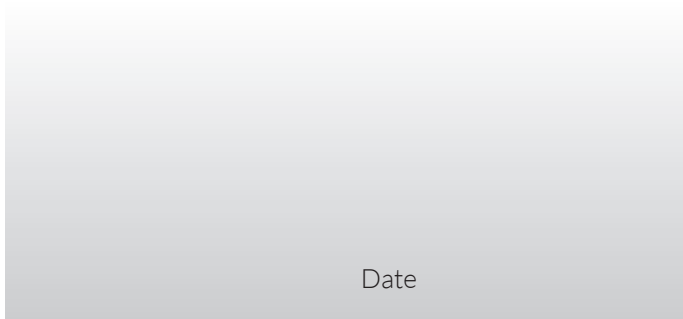

Date

84 Months

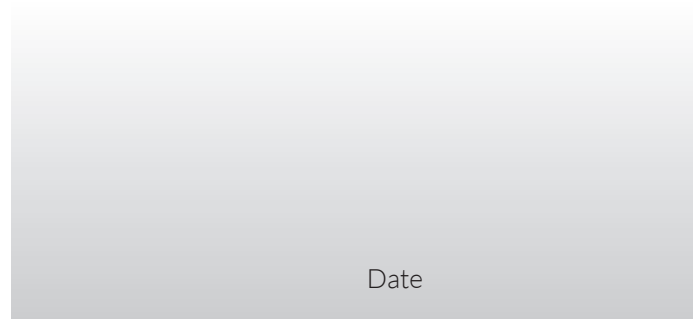

Date

96 Months

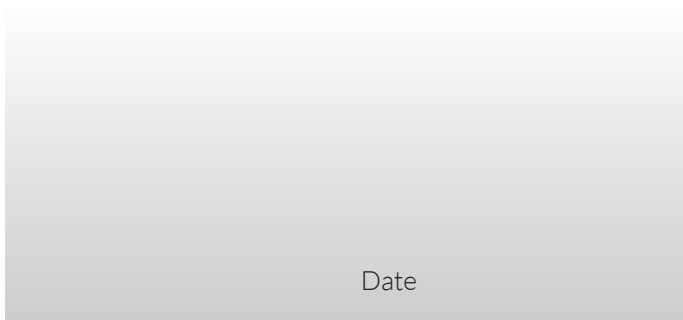

Date

108 Months

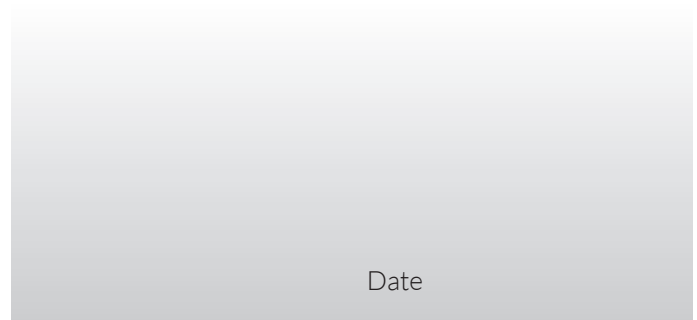

Date

120 Months

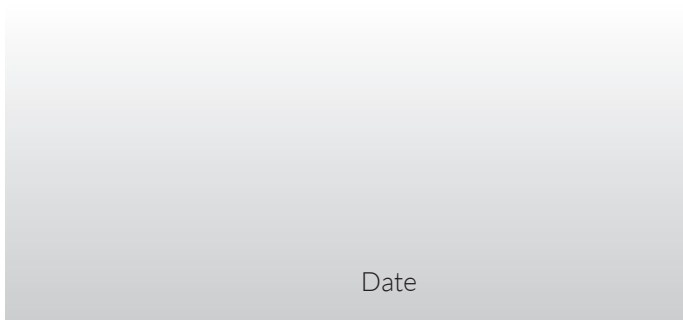

Date

132 Months

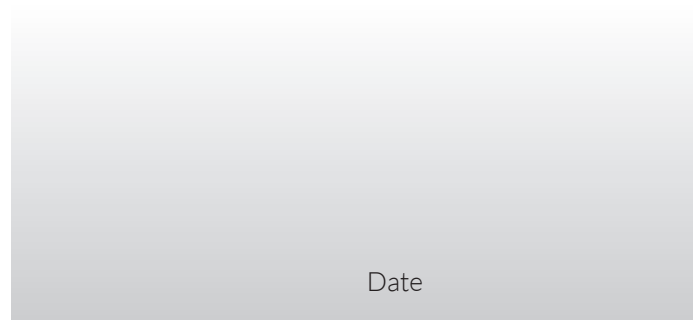

Date

# SERVICE BOOK

If you have registered online, this form is not necessary.  
PLEASE POST THIS COPY TO THE ADDRESS OVERLEAF

## Product Information (\* Compulsory)

*Model No:	
*Product No:	
*Serial No:	
*Date of Purchase:	

## Personal Information (\* Compulsory)

*Title		*Forename		*Surname		
*House Number		*House Name				
*Address 1						
*Address 2						
*Town						
*County						
*Postcode						
Home Tel		Mobile Tel				
Email						
Age	18 to 25	26 to 35	36 to 45	46 to 60	61 to 80	81 & over

## \*Dealer Stamp (Complete Address)

\*Selling Retailer (If dealer stamp not available)

*Dealer Name	
*Dealer Address	
*Date of Purchase	

*Usage	Domestic Use		Commercial/Professional/Hire Use	
--------	--------------	--	----------------------------------	--

Webb Lawnmowers' privacy commitment to machine owners: Thank you for completing this form. The information supplied, helps us to improve the products & services we provide, including information that we believe is relevant to your and/or your machine. We value your trust by giving us this information about yourself and we are committed to protecting your privacy. From time to time Webb, its associated companies, authorised dealers or third parties working on our behalf may wish to contact you regarding our products, services, offers, technical improvements or just opinions, which may be used for marketing, research or analysis purposes.

If you DO NOT wish to be contacted by either of the following methods, please tick the relevant box POST  TELEPHONE

If you would like us to contact you by Email, please tick this box

You may give Webb Lawnmowers notice in writing at any time that you no longer wish to receive direct marketing communications

Webb Lawnmowers  
Murdock Road  
Dorcan  
Swindon  
Wiltshire  
SN3 5HY